

# Turmdrehkran

Tower Crane / Grue à tour / Gru a torre  
Grúa torre / Guindaste de torre

## 280 EC-H 16

## 280 EC-H 16 Litronic®

**280 EC-H 8**  
**280 EC-H 8 Litronic®**

**280 EC-H 12**  
**280 EC-H 12 Litronic®**

**280 EC-H 16**  
**280 EC-H 16 Litronic®**

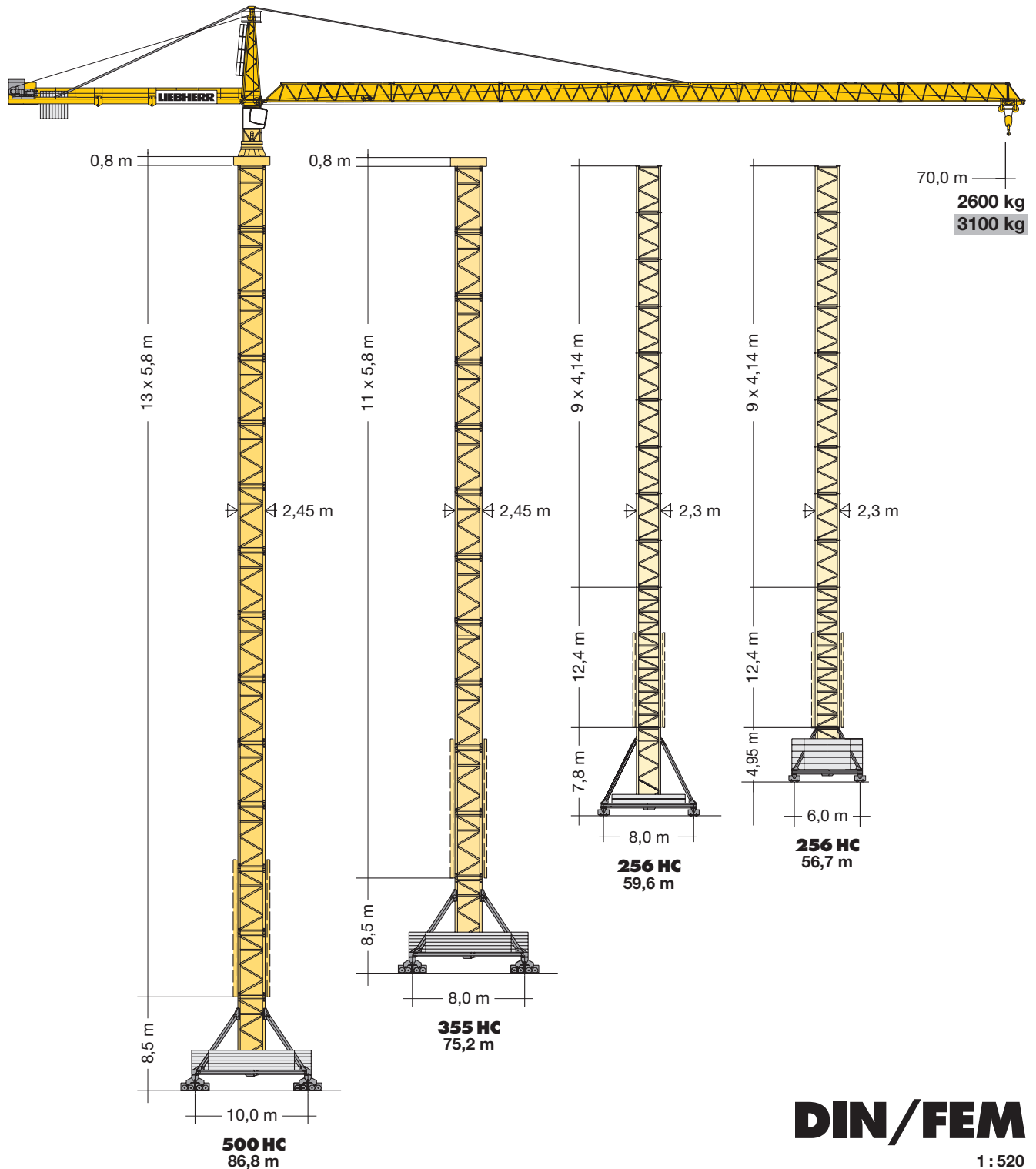

# LIEBHERR

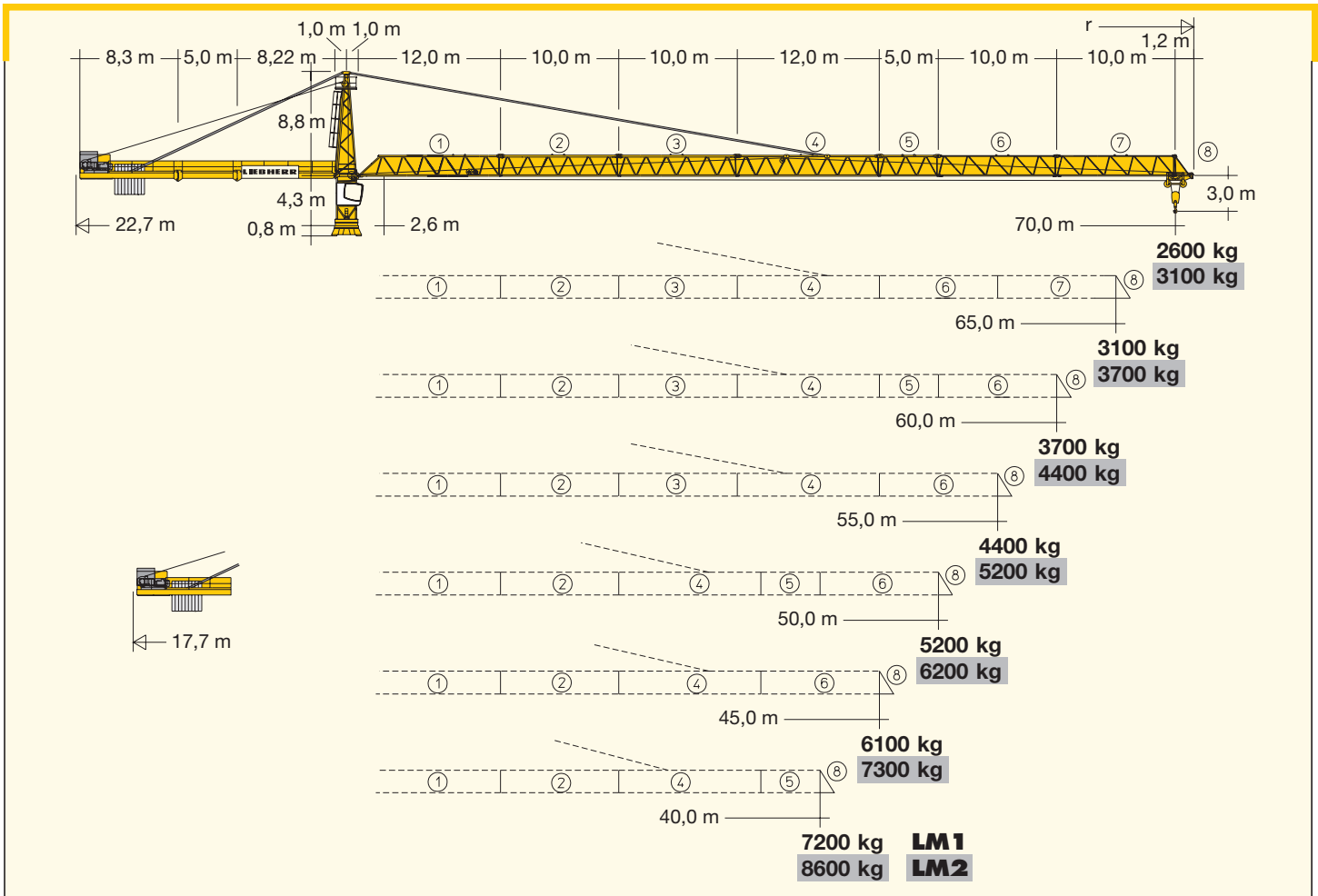

## Hubhöhe

Hoisting height / Hauteur sous crochet / Altezza di sollevamento / Altura bajo gancho / Altura de montagem

	256 HC		355 HC		500 HC			
13	-	-	-	-	-	78,7*	86,8*	
12	-	-	-	-	-	72,9	81,0	
11	-	-	-	-	67,1*	75,2*	67,1	75,2
10	-	-	-	-	61,3	69,4	61,3	69,4
9	52,0**	56,7**	52,0**	59,6**	55,5	63,6	55,5	63,6
8	47,9**	52,6**	47,9**	55,5**	49,7	57,8	49,7	57,8
7	43,7	48,4	43,7	51,3	43,9	52,0	43,9	52,0
6	39,6	44,3	39,6	47,2	38,1	46,2	38,1	46,2
5	35,4	40,1	35,4	43,0	32,3	40,4	32,3	40,4
4	31,3	36,0	31,3	38,9	26,5	34,6	26,5	34,6
3	27,2	31,9	27,2	34,8	20,7	28,8	20,7	28,8
2	23,0	27,7	23,0	30,6	14,9	23,0	14,9	23,0
1	18,9	23,6	18,9	26,5	9,1	17,2	9,1	17,2
0	14,7	19,4	14,7	22,3	3,3	11,4	3,3	11,4
	m		m		m		m	

\* **LM 2** Nicht möglich. / Not possible. / Pas possible. / Non possibile. / No posible. / Nao é possível.

\*\* Weitere Hubhöhen sowie Klettern im Gebäude auf Anfrage. / Further hoist heights and climbing in the building on request.  
 Hauteurs sous crochet plus élevées et hissage dans le bâtiment sur demande. / Altre altezze di sollevamento come pure varianti di gru allungabili: su richiesta. / Para alturas bajo gancho superiores y trepado en el interior del edificio, consultar. / Outras alturas de elevação e subida no edifício: conforme ao pedido.

# Ausladung und Tragfähigkeit

Radius and capacity / Portée et charge / Sbraccio e portata / Alcances y cargas / Alcance e capacidade de carga

		<b>280 EC-H 16</b>																							
m	r	m/kg	m/kg																						
			20,0	22,0	24,0	26,0	28,0	30,0	32,0	34,0	36,0	38,0	40,0	42,0	45,0	48,0	50,0	52,0	55,0	58,0	60,0	62,0	65,0	68,0	70,0
70,0	(r = 71,6)	2,6-19,0 14000	13230	11860	10720	9760	8940	8230	7610	7070	6580	6150	5760	5410	4940	4530	4280	4050	3750	3470	3300	3140	2920	2720	2600
65,0	(r = 66,6)	2,6-19,8 14000	13820	12390	11210	10210	9360	8620	7970	7410	6900	6450	6050	5680	5190	4770	4510	4280	3960	3670	3490	3330	3100		
60,0	(r = 61,6)	2,6-18,3 16000	14460	12970	11740	10700	9810	9040	8370	7780	7250	6780	6360	5980	5470	5030	4760	4520	4180	3880	3700				
55,0	(r = 56,6)	2,6-19,0 16000	15060	13520	12240	11160	10240	9440	8740	8130	7590	7100	6660	6270	5740	5280	5000	4750	4400						
50,0	(r = 51,6)	2,6-19,5 16000	15570	13980	12660	11550	10600	9770	9060	8420	7860	7360	6910	6500	5960	5480	5200								
45,0	(r = 46,6)	2,6-19,9 16000	15890	14270	12930	11790	10830	9990	9260	8610	8040	7530	7070	6650	6100										
40,0	(r = 41,6)	2,6-20,2 16000	16000	14510	13150	12000	11010	10160	9420	8770	8190	7670	7200												

**LM 1**

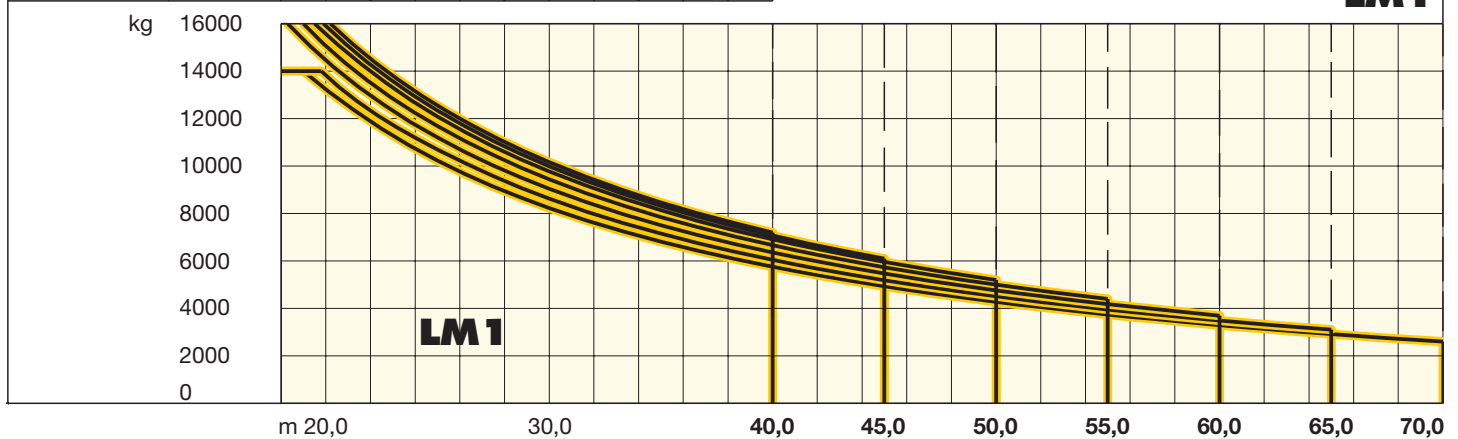

# Antriebe

Driving units / Mécanismes d'entraînement / Azionamenti / Mecanismos / Mecanismos

	U/min 0 ↔ 0,7 sl./min tr./min	2 x 6,3 kW
	0 ↔ 91,0 m/min	10,5 kW FU
	25,0 m/min	4 x 7,5 kW 500 HC, 355 HC (550 HC, 390 HC) 2 x 7,5 kW 256 HC (290 HC)
	<b>kVA</b>	45 kW FU 65 kW FU 90 kW FU 67,0 91,0 116,0

45,0 kW FU  
WIW 260 VZ 404

92,0 m

↔ **stufenlos** / stepless / régl. continu  
régl. progressive / sin escalones / sem degraus  
kg m/min

<b>1</b>	16000	0 ↔ 15
	3100	0 ↔ 54
<b>2</b>	8000	0 ↔ 26
	1350	0 ↔ 94

**1** Gang / Speed / Vitesse  
Marcia / Velocidad  
Velocidade

**2** Gang / Speed / Vitesse  
Marcia / Velocidad  
Velocidade

Elmag-Hubwerke: siehe Broschüre „Zusätzliche Hubwerksvarianten“ / Hoist gears: see brochure „Additional hoist gear variants“  
 Mécanismes de levage: voir brochure „Variantes supplémentaires du mécanisme de levage“ / Argani ad innesto elettromagnetico: vedere  
 prospetto „argani alternativi“ / Mecanismos de elevación de Elmag: Ver folleto „Mecanismos de elevación adicionales“ / Mecanismos de  
 elevacao de ÉLMAG: Ver Folheto „Mecanismos de elevação adicionais“

# Ausladung und Tragfähigkeit

Radius and capacity / Portée et charge / Sbraccio e portata / Alcances y cargas / Alcance e capacidade de carga

m	r	m/kg	m/kg																						
			20,0	22,0	24,0	26,0	28,0	30,0	32,0	34,0	36,0	38,0	40,0	42,0	45,0	48,0	50,0	52,0	55,0	58,0	60,0	62,0	65,0	68,0	70,0
70,0	(r=71,6)	2,6-21,3 14000	14000	13480	12200	11120	10200	9410	8710	8100	7560	7070	6640	6240	5720	5260	4980	4730	4380	4070	3880	3710	3460	3240	3100
65,0	(r=66,6)	2,6-22,3 14000	14000	14000	12850	11730	10760	9930	9200	8560	7990	7480	7030	6610	6060	5580	5290	5030	4670	4340	4140	3960	3700		
60,0	(r=61,6)	2,6-20,7 16000	16000	14900	13510	12330	11320	10450	9690	9020	8420	7890	7410	6980	6410	5900	5600	5330	4950	4610	4400				
55,0	(r=56,6)	2,6-21,4 16000	16000	15550	14090	12870	11820	10920	10130	9430	8810	8260	7760	7320	6720	6200	5880	5590	5200						
50,0	(r=51,6)	2,6-22,3 16000	16000	16000	14760	13490	12390	11450	10630	9900	9260	8680	8160	7690	7070	6530	6200								
45,0	(r=46,6)	2,6-22,9 16000	16000	16000	15200	13890	12760	11800	10950	10200	9540	8950	8420	7940	7300										
40,0	(r=41,6)	2,6-23,3 16000	16000	16000	15500	14160	13020	12040	11180	10420	9740	9140	8600												

**LM1 + LM2**

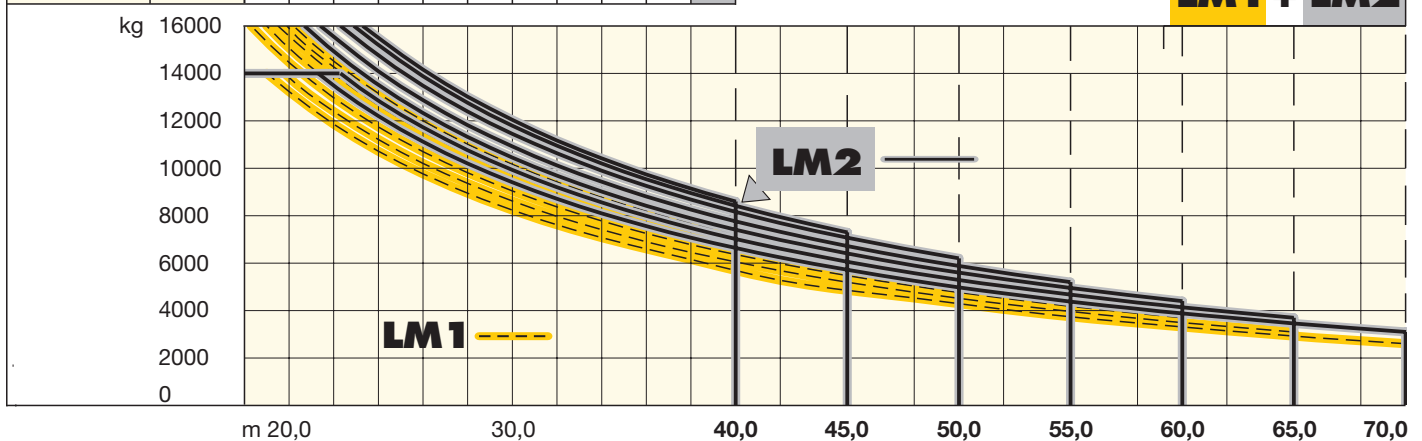

# Antriebe

Driving units / Mécanismes d'entraînement / Azionamenti / Mecanismos / Mecanismos



65,0 kW FU  
WIW 280 VZ 403

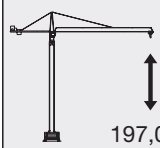

197,0 m

↔ **stufenlos** / stepless / régl. continu  
regl. progressiva / sin escalones / sem degraus  
kg m/min

**1** 16000 0 ↔ 21  
3100 0 ↔ 74

**2** 9000 0 ↔ 35  
900 0 ↔ 129

5 **Lagen**  
Layers  
Couches  
Strati  
Camadas  
Capas



90,0 kW FU  
WIW 290 VZ 407

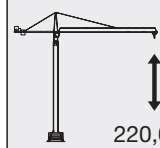

220,0 m

↔ **stufenlos** / stepless / régl. continu  
regl. progressiva / sin escalones / sem degraus  
kg m/min









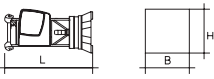
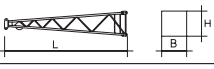
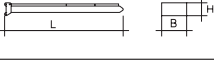

**1** 16000 0 ↔ 28  
8100 0 ↔ 47

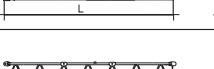
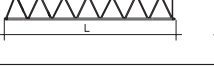

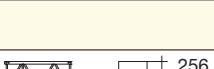
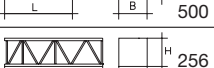
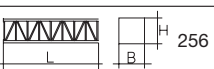
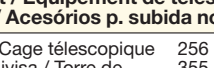
**2** 9500 0 ↔ 46  
4200 0 ↔ 80

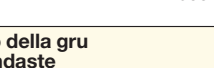
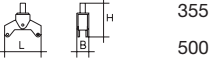
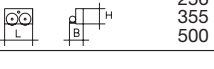
**3** 5200 0 ↔ 76  
1900 0 ↔ 134

6 **Lagen**  
Layers  
Couches  
Strati  
Camadas  
Capas

**LM 2** Abweichende Geschwindigkeiten und Betriebsbedingungen. / Variant speeds and service conditions. / Vitesses et conditions de fonctionnement différentes. / Differenti velocità e condizioni di funzionamento. / Otras velocidades y características de funcionamiento. / Outras velocidades e características de funcionamento.

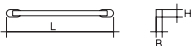
<b>Kranoberteil</b>		<b>Upper part of crane / Partie supérieure de grue / Parte superiore della gru</b>	<b>Parte superior grúa / Parte superior do guindaste</b>	<b>L (m)</b>	<b>B (m)</b>	<b>H (m)</b>	<b>kg*</b>	
Pos. Item Rep. Voce Pos. Ref.	Anz. Qty. Qta. Cant.	<b>Drehbühne / Slewing platform / Ensemble mât-cabine / Piattaforma girevole / Conjunto plataforma de giro / Plataforma giratória</b>		5,49	2,74	2,68	10120	
1	1							
2	1	<b>Turmspitze / Tower head</b> Porte-flèche / Cuspide / Cabeza de torre Cabeça de apoio de lança		9,09	1,70	1,92	2800	
3	1	<b>Gegenausleger Kopfstück / Counter-jib head</b> Pointe de contre-flèche / Testa di controbraccio Tramo punta de contrapluma / Cabeça de contra-lança		8,48	2,45	0,92	3050	
4	1	<b>Gegenausleger Anlenkstück / Counter-jib heel section</b> Pied de contre-flèche / Settore articolato di controbraccio / Tramo primero-contrapluma Base articulada da contra-lança		8,44	1,77	0,92	2800	
5	1	<b>Gegenausleger Zwischenstück / Intermediate counter-jib section</b> Elément interm. de contre-flèche Spezzione di controbraccio / Tramo intermedio de contrapluma / Peça complementar da contra-lança		5,22	1,76	0,92	1550	
6	1	<b>Ausleger Anlenkstück / Jib heel section</b> Pied de flèche / Settore articolato di braccio Base articulada de lança / Pluma tramo primero		12,26	1,86	1,96	① 3300	
7	1	<b>Ausleger Zwischenstück / Intermediate jib section</b> Elément intermédiaire de flèche / Spezzione di braccio Peça complementar da lança / Tramo intermedio pluma		10,26	1,63	1,87	②+③ 1950	
1	12,28			1,63	1,86	④ 2260		
1	5,32			1,63	1,86	⑤ 820		
1	10,27			1,63	1,86	⑥ 1220		
1	10,26			1,63	1,84	⑦ 800		
8	1	<b>Ausleger Kopfstück / Jib head</b> Pointe de flèche / Punta freccia Cabeça de lança / Tramo punta de pluma		1,70	1,88	2,05	⑧ 280	
9	1	<b>Laufkatze und Lasthaken / Trolley and hook</b> Chariot de distribution et crochet / Carrello con gancio Carrito y gancho / Carro de ponte e gancho		1,89	1,83	1,57	1520	
10	1	<b>Hubwerkseinheit / Hoist gear unit / Treuil de levage</b> Gruppo meccanismo sollevamento / Mecanismo de elevación / Grupo de mecanismo elevatório		280 VZ	2,30	2,75	1,77	5800
<b>Turm</b>		<b>Tower / Mât / Torre</b>	<b>Torre / Torre</b>					
11	9	<b>Turmstück / Tower section</b> Elément de mât / Elemento di torre Torre / Torre		256 HC (290 HC)	4,14	2,30	2,30	2300
11	355 HC (390 HC)			6,28	2,45	2,45	5315	
13	500 HC (550 HC)			6,28	2,45	2,45	6400	
12	1	<b>Turmstück lang / Long tower section</b> Elément de mât long / Elemento di torre, lungo Tramo de torre largo / Peça de torre, comprida		256 HC (290 HC)	12,42	2,30	2,30	5770
13	1	<b>Grundturmstück / Base tower section</b> Mât de base / Elemento di torre base Tramo torre base / Peça de base de torre		256 HC (290 HC)	8,85 (12,42)	2,30 (2,30)	2,30 (2,30)	4830 (7935)
<b>Klettereinrichtung</b>		<b>Climbing equipment / Equipement de télescopage / Attrezzatura per allungamento della gru</b>		<b>Equipo de trepado / Acesórios p. subida no edifício</b>				
14	1	<b>Führungsstück kpl., geteilt / Guide section cpl., split / Cage télescopique cpl., dévisée / Gabbia di sopraelevazione compl., suddivisa / Torre de montaje, dividida / Peça de guia, subdividida</b>		256 HC (290 HC)	8,39	2,68	2,58 (3,04)	4600
	355 HC (390 HC)			12,39	2,75	1,58	8300	
	500 HC (550 HC)			12,39	2,75	1,58	8300	
15	1	<b>Hydraulikanlage, Stütz- und Klettertraverse / Hydraulic unit, supporting and climbing cross members / Système hydraulique avec traverses d'appui et de télescopage / Sistema hidráulico, travesa de appoggio e allungamento gru / Instalação hidráulica, travessa de apoio e subida / Sistema hidráulico con travesa de apoyo y trepado</b>		256 HC (290 HC)	2,10	1,25	1,00	1150
	355 HC (390 HC)			2,10	1,10	1,00	1810	
	500 HC (550 HC)			2,10	1,10	1,00	1810	
<b>Unterwagen</b>		<b>Undercarriage / Châssis / Carro della gru</b>		<b>Carro con mástil / Carro de guindaste</b>				
16	4	<b>Ausgleichsschwinge mit Schwingenlager / Pivot for wheel box / Chape pour bogie / Bilanciere di equilibratura con cuscinetto bilanciere / Balancin Balancim com suporte</b>		355 HC (390 HC)	1,60	0,72	1,48	1390
	500 HC (550 HC)							
17	2	<b>Fahrschemel mit Antrieb / Rail bogie with drive</b> Bogie moteur / Telaio con gruppo propulsore Quadro sem grupo de propulsão / Caja rodillo motriz		256 HC (290 HC)	1,63 (1,46)	0,92 (0,84)	0,95 (0,87)	1690 (920)
4	355 HC (390 HC)			1,40	0,75	0,65	920	
4	500 HC (550 HC)			1,45	0,82	0,72	1690	
18	2	<b>Fahrschemel ohne Antrieb / Rail bogie without drive</b> Bogie fou / Telaio senza gruppo propulsore / Quadro com grupo de propulsão Caja rodillo conducido		256 HC (290 HC)	1,37 (1,15)	0,62 (0,60)	0,95 (0,87)	1340 (880)
4	355 HC (390 HC)			1,10	0,60	0,65	880	
4	500 HC (550 HC)			1,30	0,40	0,72	1340	
19	1	<b>Tragholm lang / Long support arm</b> Longeron long / Longherone lungo Brazo largo soporte / Travessa comprida		256 HC (290 HC)	9,10 (11,85)	0,80 (0,82)	0,80 (0,80)	1650 (2200)
2	355 HC (390 HC)			11,82	0,92	0,93	3515	
2	500 HC (550 HC)			7,32	0,92	0,93	2330	
20	2	<b>Tragholm kurz / Short support arm</b> Longeron court / Longherone corto Brazo corto soporte / Travessa curta		256 HC (290 HC)	4,45 (5,58)	0,77 (0,65)	0,77 (0,77)	800 (1035)
	355 HC (390 HC)			5,74	0,80	0,90	1600	
	500 HC (550 HC)			7,14	0,80	0,90	2135	

Pos. Item Rep Voce Pos. Ref.	Anz. Qty. Qté. Qta. Cant. Cant.			L (m)	B (m)	H (m)	kg*	
21	2 + 2	<b>Randträger</b> / Border support Traverse / Supporti base Traviesa / Apoio de bordo		256 HC (290 HC)	5,46 – 5,40	0,11 – 0,18	0,16 – 0,38	175 – 525
				355 HC (390 HC)	(7,52 – 7,46)	(0,1 – 0,17)	(0,1 – 0,38)	(366 – 912)
				500 HC (550 HC)	7,30	0,14	0,14	340
22	4	<b>Stützholm</b> / Support strut Hauban de châssis / Correnti di appoggio Tirante vertical / Travessa de apoio		256 HC (290 HC)	4,14 (6,55)	0,18 (0,22)	0,25 (0,25)	320 (600)
				355 HC (390 HC)	6,06	0,26	0,34	862
				500 HC (550 HC)	6,98	0,26	0,34	1140
23	1	<b>Unterswagen-Turmstück</b> / Undercarriage tower section / Mât de châssis / Elemento di torre del carro / Tramo de carro / Peça de torre do chassis		256 HC (290 HC)	3,73 (6,70)	2,62 (2,53)	2,62 (2,53)	2550 (3800)
				355 HC (390 HC)	6,61	2,44	2,44	7475
				500 HC (550 HC)	6,61	2,44	2,44	7930
24		<b>Kleinteile, Seile und Abspannungen</b> / Small parts, ropes and holding bars Accessoires, câbles et tirants / Accessori, funi e attrezzi di ancoraggio Despieces, cables y tirantes / Acessórios, cabos e peças de ancoragem		256 HC (290 HC)	9,00	1,60	1,00	4000
				355 HC (390 HC)				
				500 HC (550 HC)				

( ) **Angaben in Klammern gelten für 8 m-Unterswagen.** / The data in brackets are valid for an undercarriage of 8 m. / Les données techniques indiquées entre parenthèses sont valables pour un châssis de 8 m. / Caratteristiche in (..) valgono per carro di 8 m. / Los datos entre paréntesis son válidos para carro de 8 m. Características em (..) válidas pelo chassis de 8 m.

\* **Einzelgewichte.** / Single weights. / Poids individuels. / Pesì di componenti. / Pesos de peças componentes. / Pesos unitarios.

**Konstruktionsänderungen vorbehalten!**

Subject to alterations! / Sous réserves de modifications!  
Si fa riserva di modifiche! / Salvo modificação da construação!  
¡Sujeto a modificaciones!

**Sämtliche Angaben erfolgen ohne Gewähr.** / This information is supplied without liability.

Ces renseignements sont sans garantie. / Le indicazioni contenute si intendono salvo errori ed omissioni.  
Declinamos toda responsabilidad derivada de la información proporcionada. / Declinamos qualquer  
responsabilidade quanto à informação fornecida.